

# Built-in Shutter Systems

The aesthetic way to secure the building envelope



# Working Together At Every Stage Of Your Project

---

## Technical Support

We can provide technical support during the important design stage of your project to assist you and ensure that you have all the information you require.

## Approved Installer Network

SWS UK has developed an extensive network of approved installers/distributors, each one selected for the quality of service they provide to their customers and the depth of knowledge they have. The distribution network covers the entire UK, ensuring that no matter where your development is you will have access to a specialist installer/distributor right on your doorstep.

## Qualified & Trained

SWS UK's experienced and professional installers have undergone rigorous training to ensure that you are always guaranteed high standards of service.



## After Sales

A comprehensive after sales service will continue to meet your needs at the end of your project and beyond.



## Safe & Secure

Safety is a fundamental concern in the continuing development of our product range. All shutters are CE marked by the manufacturer under the Construction Products Directive and we support installer CE marking under the Machinery Directive.





Internal view

# The Product

## **Very Unobtrusive - Very Effective**

Our built-in security window shutters have been developed to provide an architecturally compatible answer to the growing need for vandalism and burglary protection on domestic and commercial property.

## **Design**

Built-in shutters give all the benefits of easily operated security at night, but disappear by day, leaving the building attractive and welcoming. Building the shutter box and guide rails into the wall during construction or major refurbishment achieves a neat finish and, more importantly, high levels of security. Window shutters are easy to operate from inside, manually or electronically. Where desirable, punched or perforated slats can be added to provide varying levels of vision and light. The unobtrusive design helps in meeting the demands of many of the more stringent planning authorities.

## **Secure**

Once the shutters are fully lowered, a mechanical lock will secure the shutter, providing high levels of security and peace of mind. The shutters may be used to achieve shading enhanced by optional light slits on the foam filled slats, or complete blackout.

## **Environment**

Our built-in shutters can incorporate intelligent control systems that allow the user complete control of their environment. They are able to regulate levels of light, shading, warmth and sound to suit individual requirements.

# Component Parts

SWS UK's built-in Shutter Systems are made to the highest standards, using a variety of high quality component parts. The result is a superior security product with high levels of performance.

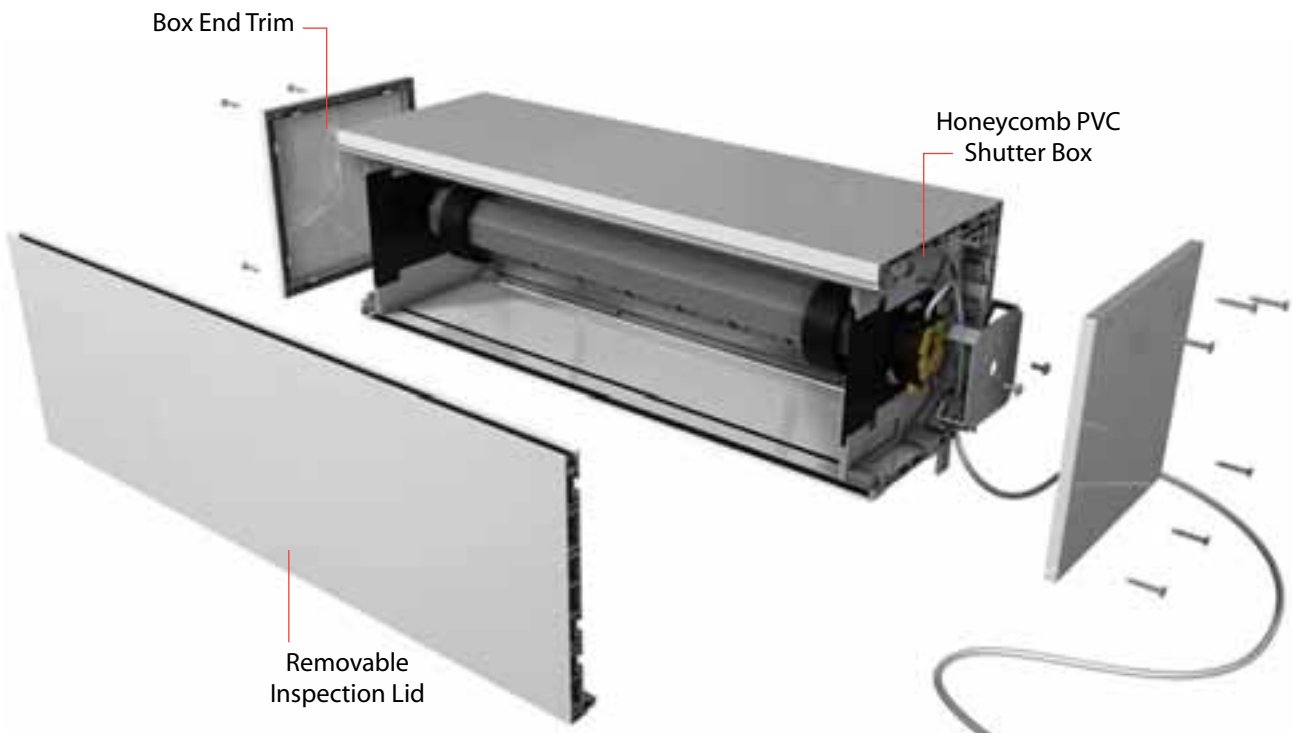

## Shutter Box

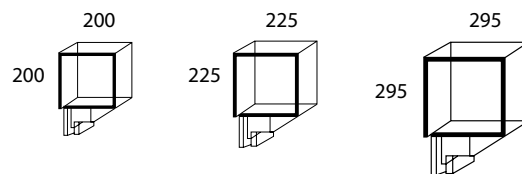

Maximum Frame height	1800mm	2475mm	3705mm
Overall height including box	2000mm	2700mm	4000mm

The white honeycomb PVC outer casting provides maximum insulation and prevents condensation. The removable inspection lid across the vertical internal face has a clip fitting that withstands draughts and moisture. This lid enables routine maintenance of the shutter without affecting the internal decor of the building.

There are three alternative box sizes, with selection dictated by the height of the opening, as described in the table above.

### Colour Options:

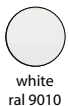

## Guide Rail

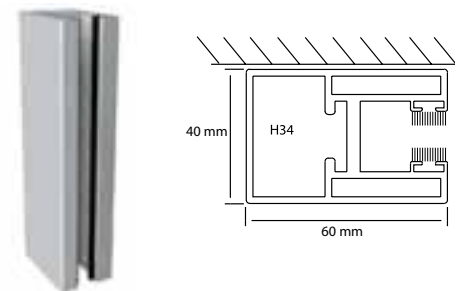

The guide rail is manufactured from extruded aluminium with a box section for fixing and high density 5mm pile brush seals. The H34 guide profile is supplied as standard. The rail must be rebated behind the outer brickwork to achieve maximum security.

### Colour Options:

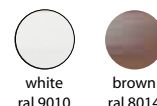

## Shutter Options



### Colour Options:

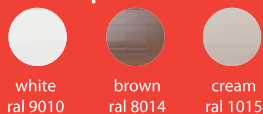

### SeceuroShield 3800

A profile for domestic and commercial applications. The slimline profile of the extruded aluminium slat is double-walled, giving exceptional strength yet tight coiling for a small shutter box.

- 38mm deep profiled twin-wall extruded aluminium slat  
(Shown below are the perforated/punched profiles which can be mixed with the solid for added light and vision options)

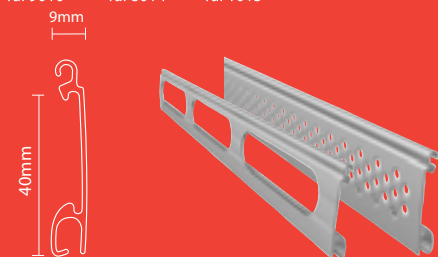

### Colour Options:

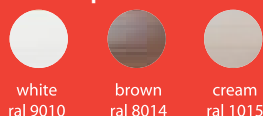

### SeceuroVision 3800

Lightweight and compact, the SeceuroVision 3800 is suited to medium security applications. The attractive punched slat design is a stylish complement to contemporary interiors.

- 38mm deep profiled single wall extruded aluminium slat
- Punched or perforated
- A clear polycarbonate glazing option is also available



### Colour Options:

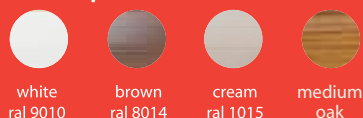

### SeceuroScreen 1500\*

Lightweight and compact, the SeceuroScreen 1500 is a CFC-free foam filled aluminium slat, offering good strength, insulation and sound deadening.

- 40mm deep profiled double wall, foam filled, rolled aluminium slat
- Spring and lock operated shutters are supplied non-vented as standard
- All other options are supplied vented as standard but are also available non-vented

\*only available in the basic colours shown

## Bottom Slat

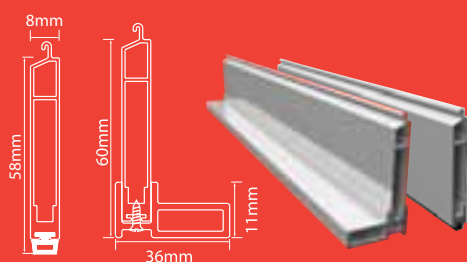

### Colour Options:

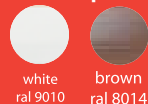

Extruded aluminium with reinforcing angle. Can be supplied with rubber base or reinforcing angle.

## Colour Options

Guide rails, reinforcing angles and shutters can be provided in a wide range of colour options.

**1. Basic Colours** – these are the standard colours indicated below each shutter type, opposite

**2. Stock Colours** – these can be provided at an extra cost from the selection below

**3. Premium Colours** – these can be matched to any RAL/BS colour and are available at a fixed additional price

### Stock Colours



These colours are indicative, not actual.

# Control Mechanisms

SWS UK offers a broad spectrum of control mechanisms to suit your individual needs, from manual systems to intelligent versions that can automatically raise or lower the shutters to control light and heat within the building. Below is a small selection of the control mechanisms available. For further information and a price guide, contact your distributor.

## Group Control

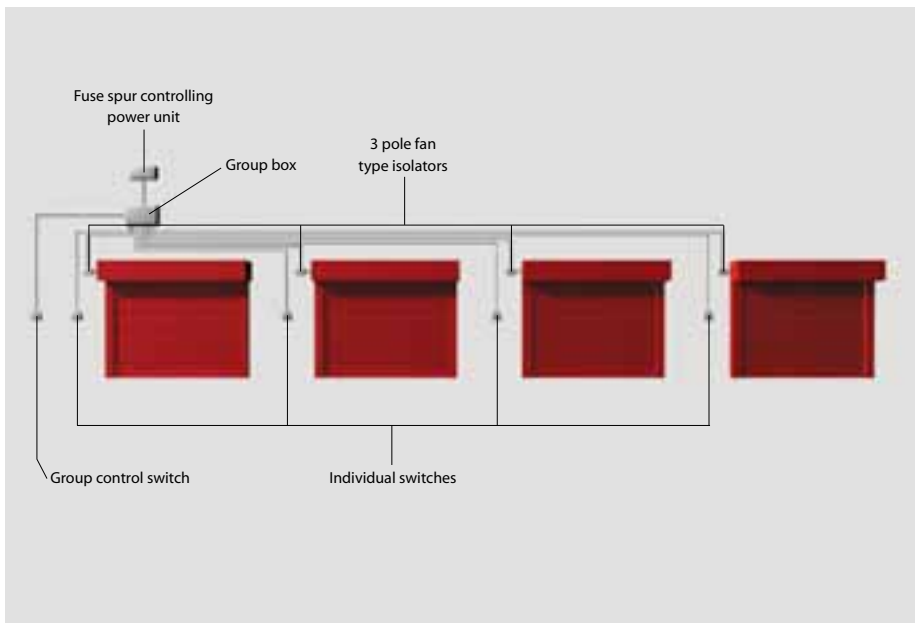

## Individual Control

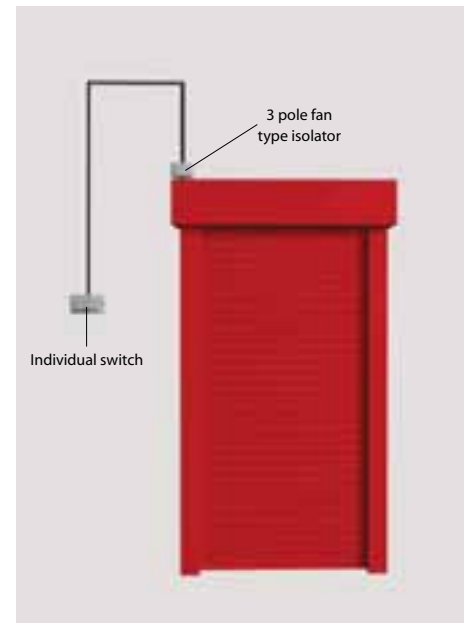

Control mechanisms are available as both single motor and group command activated motors for multiple shutters, so that shutters can be operated individually or in groups. Single rooms can be controlled individually, ensuring that the shutters are only operated in full sight of the user.

## Wired Control



### **Inis Uno Single Pole Switch For One Shutter**

This control is designed to control one shutter only. Group control will have multiple switches on the control box.



### **Key switch**

The key switch allows the user to control the shutters from outside the doorway



### **Chronis**

This wireless wall mounted control can be moved easily without the need for rewiring.



### **Telis**

This hand held unit offers complete control at the touch of a button.

# Intelligent Systems

These intelligent control systems offer convenience and flexibility and combine ease of operation with the ability to enhance your working/living environment.

Automation solutions can be used to control ventilation, temperature, sound and natural light and so help create optimum internal conditions.

Shutters can be configured to your specific requirements and adjust automatically to changing light levels, ensuring that your surroundings are always tailored to your needs.

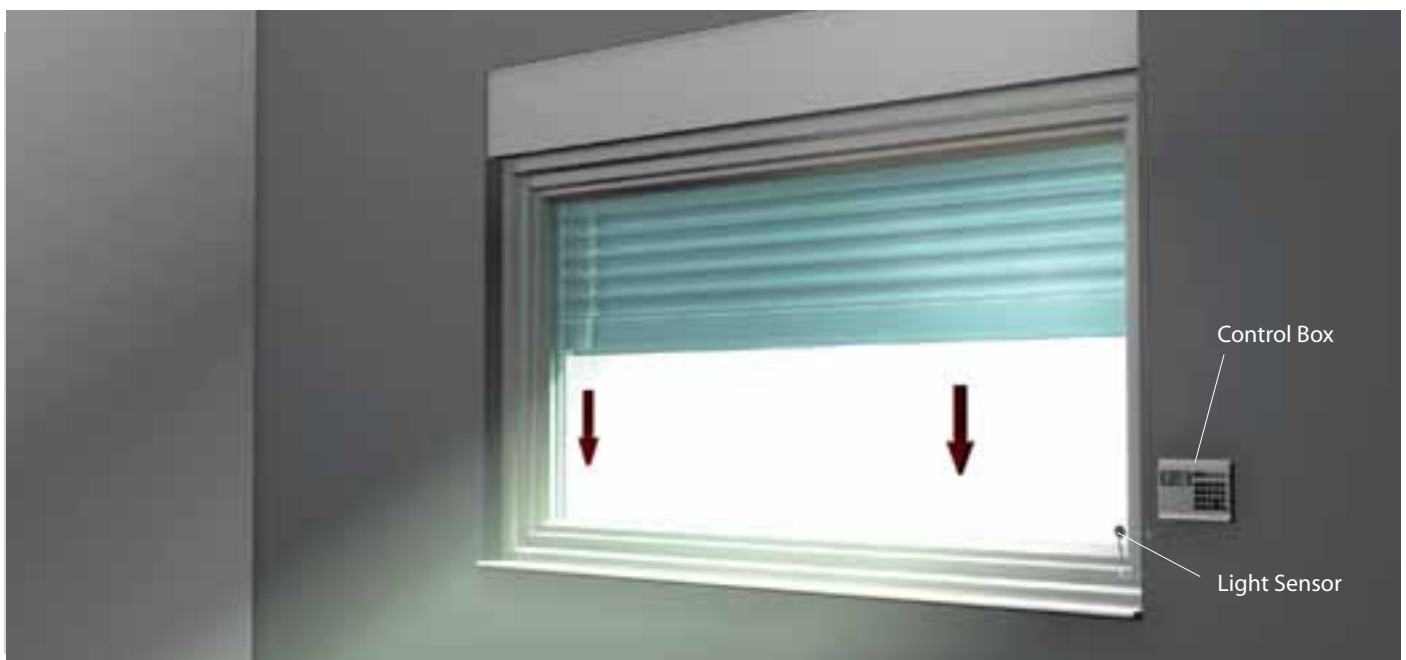

Environmentally sensitive controls can work in conjunction with timer switches, ensuring the environment is controlled in daylight hours and then secured when the building is not in use.

# Application Details

## Outward Opening

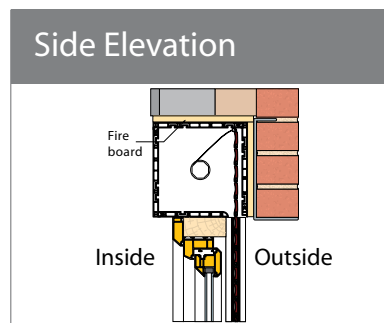
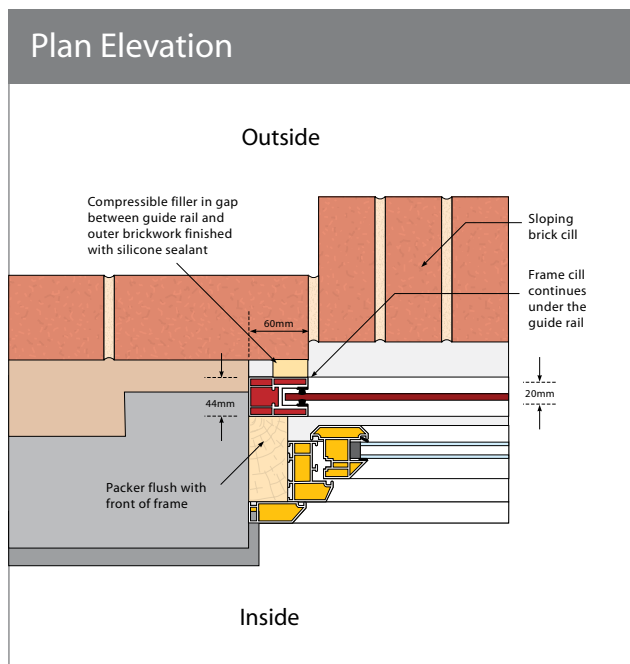

The inner blockwork is rebated at each side by the width of the guide rail. The front of the packer **is at least flush** with the front of the frame, so that the guide rail is able to overlap both. The width of the packer is varied according to how much of the frame is to be visible and the cill continues under the guide rail.

## Inward Opening

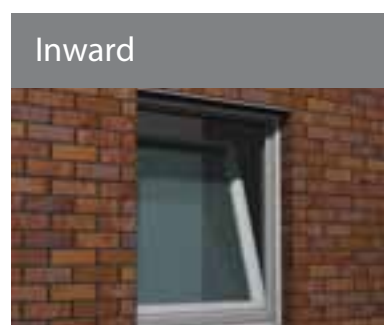
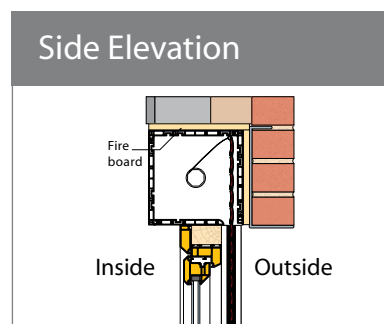
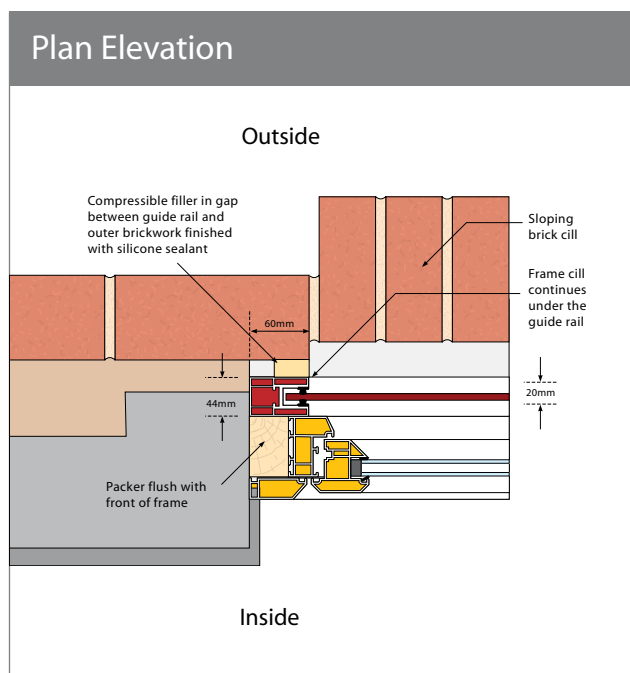

The inner blockwork is rebated at each side by the width of the guide rail. The packer is **set forward** of the frame, at least flush with the opening lights. The packer is tailored to accommodate the 60mm wide guide rail. The cill continues under the guide. This detail can be adapted to suit a doorway/window with a projecting handle.

# Typical Section

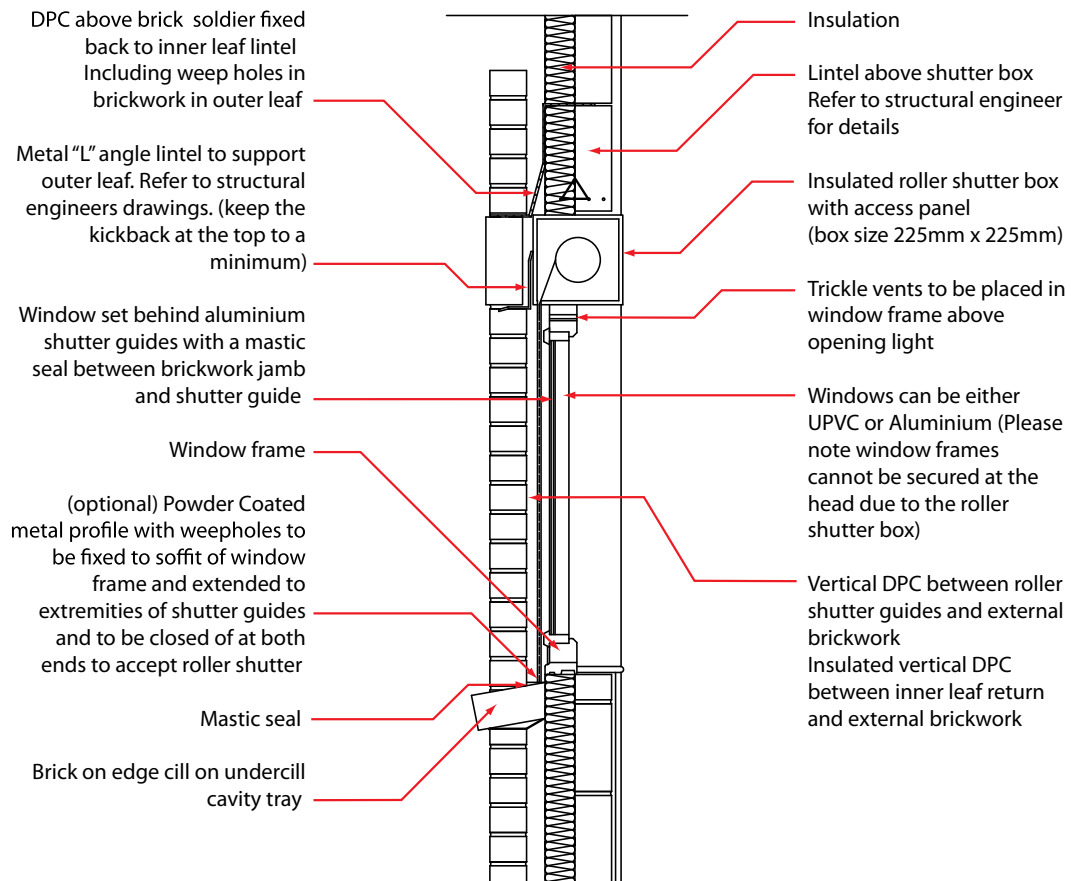
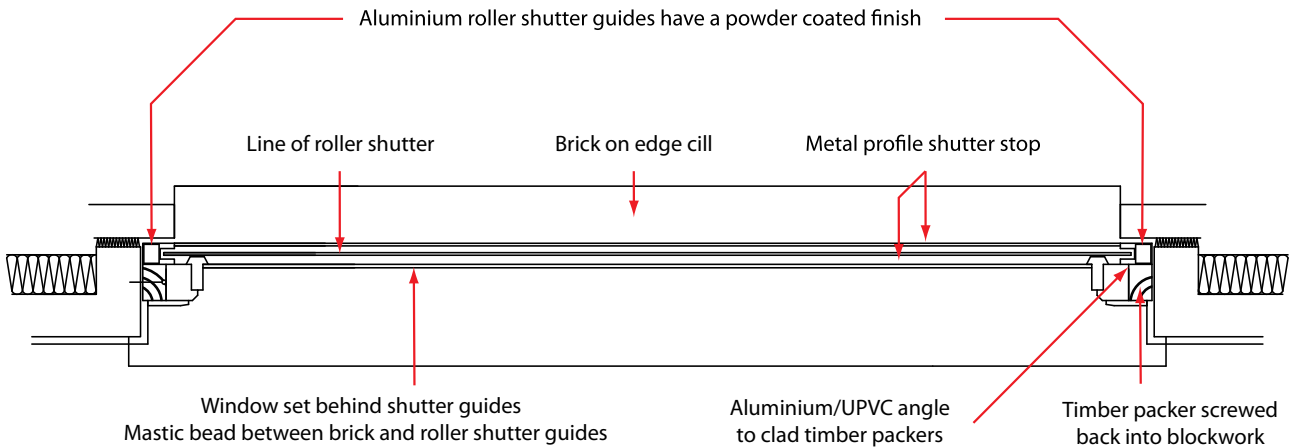

# Installation

---

## Step-by-Step

---

The installation process set out below has four simple stages. The off-site construction ensures that there are no disruptions to the build with the combined window and shutter assembly installed quickly and easily in line with the build schedule.

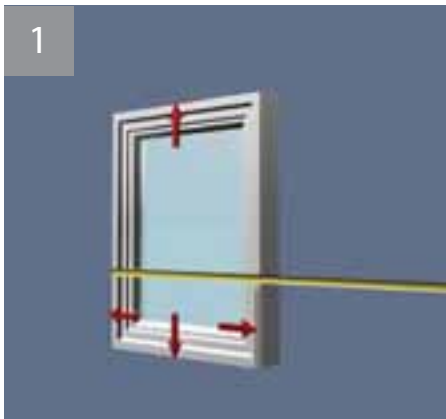

**1.** The window frames which the shutters are being attached to are measured to obtain the shutter dimensions. *The packers required must already be fitted to the window frames by the window manufacturer.* Dimensions must be taken from the actual windows, not drawings, as every shutter is made to measure.

**2.** The shutter boxes and guide rails are manufactured then attached to the window frame off-site - either at the point of manufacture or other suitable premises.

**3.** The window frames, complete with shutter boxes and guide rails, are delivered to site and installed by one of our approved installers.

**4.** When the building/rooms are ready, engineers attend the site to install the axle assemblies and curtains before commissioning the shutters. Access to the inspection panel inside the room must be maintained to allow for routine maintenance.

## Key Benefits

---

Our unobtrusive installation process offers significant benefits to builders:-

- Building operations on-site can continue whilst the window is being prepared.
- The system is simple and quick to install
- The system will work with any off-the-shelf lintel

# Building Type & Material Usage

SWS shutters have been installed nationwide, including windows and doors on urban, suburban and rural homes, office buildings, factories, hospitals, schools and many more. Our systems are flexible enough to be adapted to almost any method of construction, providing a practical, secure and aesthetically pleasing solution every time.



Stonework  
Metal Cladding  
Brickwork  
Stone Cladding



Commercial  
Leisure  
Hospitals Schools  
Industrial

Metal  
Timber  
Stone  
Brick

# A Solution For Every Project

---



## Security Shutters

The SWS UK security shutter range has been developed to provide a stylish and versatile solution for your security needs.



## Security Gates

This burglar deterrent security product combines a classic appearance with effective protection. It is ideal for home or workplace.



## Roller Garage Doors

The first insulated door of its kind and the closest you will get to the perfect automatic roller garage door. Since its launch, this product has maintained its position as market leader through continuous development and innovation.



## CPD Seminars

For further information or to book our RIBA approved CPD seminar, please contact our CPD advisor on 01524 772413, email [cpd@swsuk.co.uk](mailto:cpd@swsuk.co.uk) or visit our website.

## **SWS UK**

Claughton, Lancaster, Lancashire LA2 9LA

Tel: 01524 772 400 Fax: 01524 772 411

email: [info@sws.co.uk](mailto:info@sws.co.uk)

[www.sws.co.uk](http://www.sws.co.uk)